

Positive Control Checks...
Critical Assembly Checks...
and other Check Lists

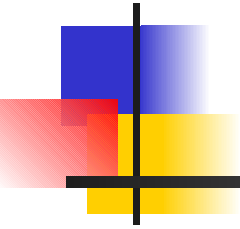



Accidents with PCC as Contributor or Cause

- SGS 1-26: After maintenance, reinstalled elevator, did “PCC”, took off and augered in on tow...fatal
 - Failure: Elevator linkages hooked up backwards
 - PCC Indicator: Control direction



Accidents with PCC as Contributor or Cause (Contd.)

- LS-1: Flying along, aileron did not return from full deflection...pilot bailed out fine
 - Failure: Bent pushrod...rivet holding connector to pushrod caught on aircraft structure
 - PCC Indicator: Pushrod inspection, binding (?)



Accidents with PCC as Contributor or Cause (Contd.)

- Standard Cirrus: Did “PCC”...2/3rds down the runway, glider finally pulled off ground by towplane...pitched up, tow rope broke, glider rolled, dived in...pilot dead
 - Failure: Misconnected elevator
 - PCC Indicator: Control throw, play in control, control deflection under load (?)
 - Note: Recommend marking normal throws on full flying stabs



Accidents with PCC as Contributor or Cause (Contd.)

- Standard Jantar: During PCC, left aileron pops off connector at full control deflection under light pressure
 - Failure: Misconnected aileron
 - PCC Indicator: Control deflection under load

Accident Summary: PCC Indicators

Accident	Pushrod Inspect	Control Direction	Throw	Control Play	Bind	Deflect Under Pressure
1-26		X				
LS-1	X				?	
Cirrus			X	X		?
Jantar						X



PCC Guidelines

- Check pushrods for wear and damage before and during assembly
- Assistant at cockpit, PIC at control surface
- Thumb up on stick points to “up” control surface
- Start PCC at aileron and walk around
- If interrupted, redo that control
- One hand on control surface, other hand on wing trailing edge to stabilize
- Don't forget to lock spoilers



Don't Damage the Glider

- Don't bang stick or control surfaces against the stops
- Use light pressure on control surface... perhaps equal to weight of forearm
- Control surfaces and trailing edges are damaged easily...apply pressure with open hand to avoid point loads
- Apply pressure at control surface strong point... typically near pushrod attach point
- For elevator, one hand on left elevator, one hand on right elevator
- For spoilers, hold by spoiler plate, not spoiler cap...be careful of your fingers



Avoid Miscommunication by Using Relative Stick Position

- “Move stick away from me”
- “Move stick towards me”
- “Move stick to center”
- “Hold”
- “Good!”
- Etc...

PCC Procedure: A Picture Tells a Thousand Words...

1) Aileron Up

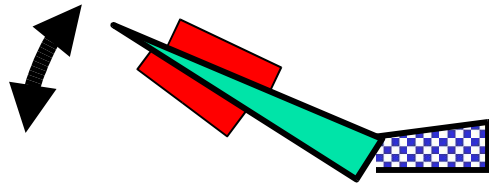

2) Aileron Up to Down

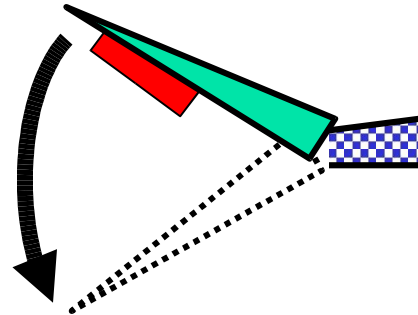

3) Aileron Down

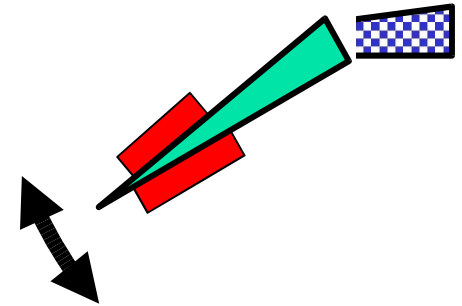

4) Aileron Down to Up

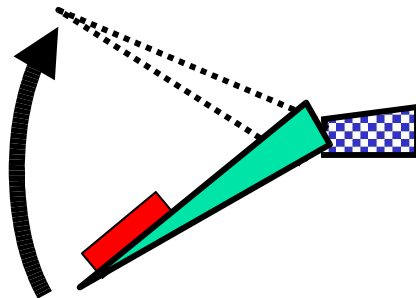

5) Aileron Center

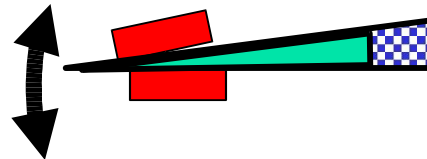

 = Hand

PCC Procedure...The Thousand Words



- (1) At full control deflection...put pressure on control surface in both directions
- (2) While moving control to opposite deflection ... apply resisting pressure on control surface
- (3) At full control deflection...put pressure on control surface in both directions
- (4) While moving control to opposite deflection ... apply resisting pressure on control surface
- (5) Center control...put pressure on control surface in both directions



Both PIC and Assistant are Equally Important

- Cross check each other
- Teach your assistant
 - Don't settle for less than what you want
- If helping someone else, teach them



CAC Failure Examples

- After landing, pilot finds wing pin not installed
- On take off roll, elevator falls off...pilot dies...stab locking pin not installed
- Rudder jams...pilot clears jam...cockpit items not secured
- In flight, instruments don't work...static ports taped shut for washing



CAC Example:

Tailor and Update as Needed

CAC - PCC

- Wing pin engaged and pinned
- Aileron linkages engaged (2)
- Elevator linkage engaged
- Elevator pin engaged and locked
- Positive control check

CAC – Finish

- Battery secure
- Weight and balance
- Weights secure
- TE Probe installed and taped
- Static and pitot ports uncovered

Non Critical Checks

- Tire Pressure
- Baggage cover taped
- Wings taped

More info at: <http://www.soaringsafety.org/Safety%20Alert%2000-1.PDF>



CAC Person

- Best to have another experienced person do CAC...fresh set of eyes
- If you must do CAC yourself, wait a few minutes after completing PCC

L'Hotellier Connectors Used on Many Ships

- Airworthiness Directive (AD) mandates specific safety pin

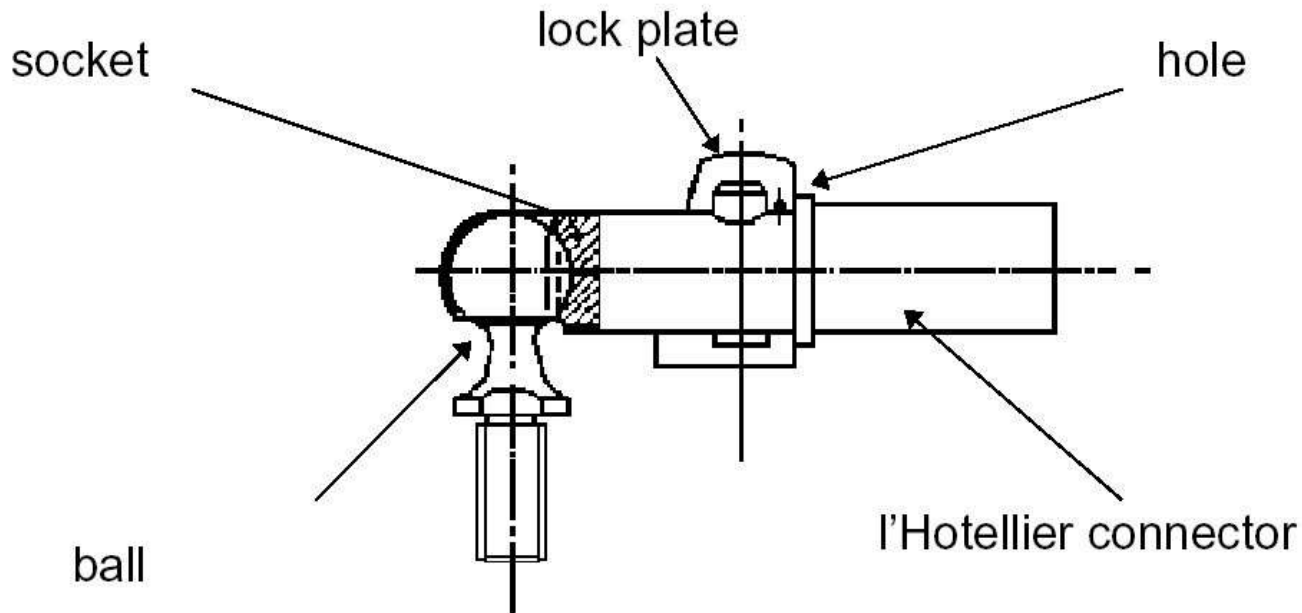



L'Hotellier Connectors (Contd.)

- Install Wedekind locking system
 - Easier to use than pins, so more reliable
 - Available from www.mandhsoaring.com or other vendors
 - More info at <http://www.sli-institute.ac.uk/~bob/dg200/hotellier.htm>

Personal Check List:

IMSAFE



- Illness
- Medication
- Stress
- Alcohol
- Fatigue
- Emotion



Pre Take Off Checklists

- Factory checklist takes precedence
- Use pilot prepared checklist
 - Permutations of CBSITCB, including Dolly, wind Direction, Emergency, Flaps
 - Example: DCBSITCBDE (Dolly, Control, Ballast, Straps, Instruments, Trim, Canopy, air Brake, wind Direction, Emergency)
 - Do what works for you and the glider



Make Your Own Checklist

- TFRs, NOTAMs, 800-WX-BRIEF...
- Car keys in car, full gas tank, trailer hooked up and ready
- Unzip fly, remove wallet, hat, map, water, erase logger, set task in computer...



Landing Checklist

- Do not use item (*) if not applicable
 - Water*
 - Undercarriage*
 - Speed
 - Trim
 - Airbrakes
 - Look



Hazardous Thoughts: We Don't Need No Stinkin'...

- I'm an expert
- I'm in a rush
- I did it yesterday
- I have automatic control hookups
- Someone else did it for me



Knowledge is the Foundation of Safety

- Thanks for all the knowledge!
 - Richard Kellerman
 - Tom Knauff
 - My instructors
 - Soaring magazine
 - Newsgroup (recreation.aviation.soaring)
 - Everyone else...good and bad!